

3M Personal Safety Division
Military Applications

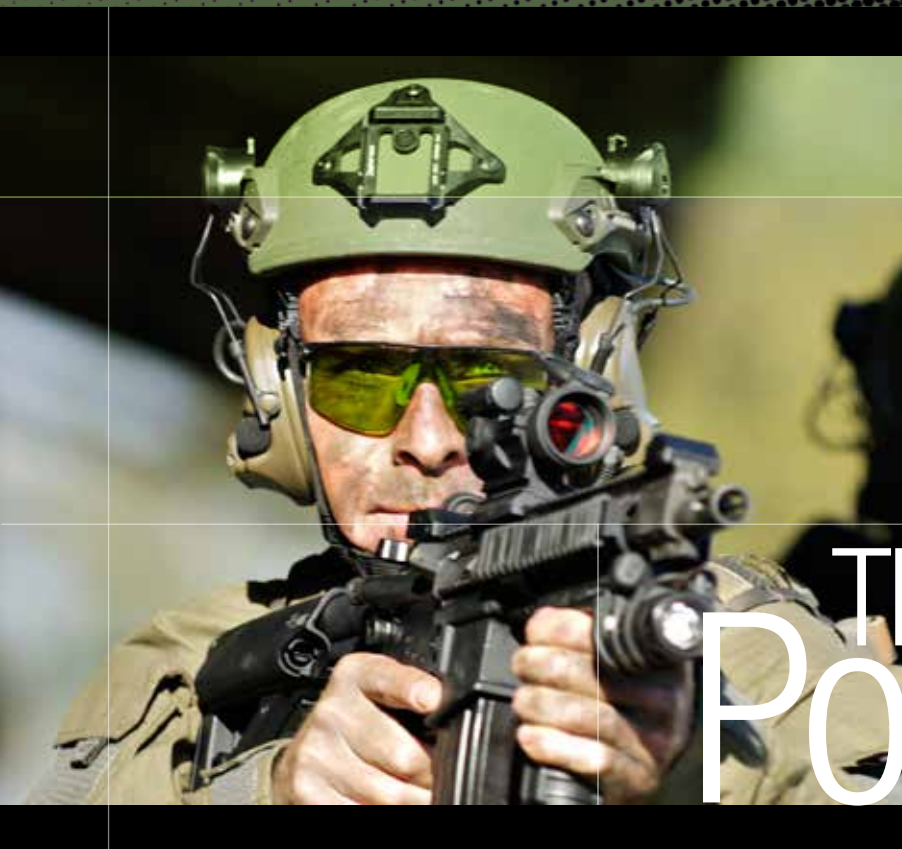

The
Power to
Protect your world



Take your safety personally

3M, a world leader in safety and protective equipment, is proud to have the PELTOR™ brand range as part of its product offering.

3M™ PELTOR™ Products include communication equipment as well as hearing, head & face protection products for noisy and hazardous environments and are renowned world leaders. With more than 60 years of experience, the PELTOR brand promises quality communication solutions that help provide an excellent balance of comfort and protection.

It is our goal to help ensure that we satisfy your needs through the provision of exceptional leadership, expertise, quality and service excellence. With our global technology, manufacturing and knowledge network we do more than simply develop products that help your workforce to operate in safety and comfort. The advanced engineering and technology inherent with the PELTOR™ brand fits with the high standard of quality and innovation of a continuously evolving range of product solutions that you, our customers, come to expect from 3M.



Protection all the way

We believe that health and safety is the priority in any working environment and that greater comfort improves worker protection and can result in enhanced productivity and help safety compliance.

Long lasting innovations

To deliver on our commitment requires a culture of accountability, customer inspired innovation, knowledge and expertise, fuelled by a deep understanding of our customer needs.

Working together

3M is more than just products. We work closely with distributors, safety professionals and companies to help employers protect employees exposed to potentially hazardous environments. With offices around the world, 3M can help our customers succeed everywhere.

Partnership in safety

Many renowned companies have chosen 3M™ PELTOR™ Products. With customised printing, embossing and other solutions, our products can also help enhance the value of your brand.



Focused on efficiency, reliability and safety

Clear and reliable communications are critical to success in most military operations. To be able to communicate whilst at the same time being protected from harmful noise levels is a vital necessity, both for exercises and actual combat situations. Noise levels are often so high that they can cause immediate and permanent damage to the hearing if proper protection is not worn. At the same time, communication is of prime and vital importance. Orders and information must be heard and understood, both via radio and directly person to person.

Mission Essential Products

3M™ PELTOR™ and 3M™ E-A-R™ Products can help you with your mission. From the 3M™ Classic™ Earplug for attenuation and comfort, to complex communication systems adapted for army, navy and airforce.



3M™ Products Military Solutions

Sharpen your senses when it matters most...

Soldier's senses must be sharp to enable successful operations. Hearing can be just as critical as vision, both in darkness and daylight. He or she must be able to hear incoming radio signals without the risk of revealing the actual location. A snapping twig or a whispered message must be heard and located. Communication over the radio must be possible, even in deafening combat situations.

All these are situations where hearing is critical to success. In combat, on a reconnaissance mission or at your post, 3M™ PELTOR™ Communication Products can sharpen your hearing.



3M™ PELTOR™ Standard System, a communication standard

3M™ PELTOR™ Standard Systems use the same connectors and adjustments to PTT buttons and adapters and are used for all headsets, facilitating usage and ensuring safer communications by reducing the use of product specific solutions. You can choose a personal headset for your individual situation and specific task, and yet be able to easily and quickly connect to other communications systems, should the need arise.

3M™ PELTOR™ Adapters are equipped with an audio input via standard J11 jacks, which means that our complete range of standard headsets can be used without any adaptation. The outgoing cord is equipped with jacks for communication radios or telephones, fitting most currently now on the market.

3M™ E-A-R™ Hearing Protection all over the world

3M™ E-A-R™ Hearing protection Products are manufactured to help anyone who spends time in noisy environments. Over 30 years ago the 3M™ E-A-R™ Classic™ Earplug was introduced. The yellow foam earplug, established new standards in hearing protection and comfort. Today this earplug continues to be the most widely recognised product in hearing protection all over the world.





Seeing is believing

Besides helping protect your hearing and helping ensure your communication capacity, 3M also offers protective eyewear with advanced optical engineering. Premium lens technology results in optics with unobstructed field of vision and gives comfortable wear with less eyestrain. Due to advanced optical engineering, 3M has developed patented innovative lens solutions which help minimize distortion in sight. 3M capabilities in eyewear also include premium coating technology, which is evident in our proprietary 3M™ DX™ Coating, and premium design that make the eyewear attractive and comfortable to wear.





ComTac Headset Solutions

The power to protect your worldSM

The 3M™ PELTOR™ ComTac Product range includes invaluable tools for people who are subjected to impulse noises. 3M™ PELTOR™ ComTac Products help protect against harmful noise while letting in and sometimes even amplifying ambient sounds.

Being able to communicate with your surroundings whilst at the same time being protected from harmful noise levels is a vital necessity in the military, both for exercises and battle situations. Noise levels are often so high that they can cause immediate, permanent damage to your hearing if proper protection is not worn.

At the same time, communication is a must. Orders and information must be heard, both over the radio and directly person to person. The 3M™ PELTOR™ ComTac Electronic Level Dependent Hearing Protector is designed for just these conditions. It is also specially designed to be worn comfortably under a helmet, be used with different kinds of weapons without being in the way, and at the same time to help protect effectively against harmful noise levels.

3M™ PELTOR™ Products ComTac Headset Solutions



PELTOR™

3M™ PELTOR™ ComTac XPI Headset Electronic Level Dependent Hearing Protector



MT20H682FB-02

MT20H682FB-02 SV

- Hearing protection
- Level-dependent function for ambient listening
- “Plug and play”, no start up time
- Foldable headband for easy storage and transport
- Configuration menu with voice guide
- Functions: release time, balance, external mute mode, EQ mode
- Earplug mode (maintains situational awareness when used in combination with earplugs)
- SNR 39 dB when combined with earplugs
- Automatic power off after two hours if no function is used
- No software loads or outside power required, complete self-contained
- Tested according to military standards
- ~ 200h (battery & temperature dependent)

Description

ComTac XPI Standard, Green
ComTac XPI Standard, Black

3M product code

XH001680905
XH001680988

Reference Id

MT20H682FB-02
MT20H682FB-02 SV

MT20H682FB-*¹

Frequency (Hz) ²	125	250	500	1000	2000	4000	8000
Mean Attenuation (dB) ³	11.5	17.9	27.8	30.0	32.1	36.2	40.3
Standard Deviation (dB) ⁴	2.5	2.7	1.8	2.3	3.0	2.0	3.1
Assumed Protection Value (dB) ⁵	9.0	15.3	25.9	27.7	29.1	34.2	37.2

According to EN352-1:2002

SNR=28dB H=31dB M=25dB L=16dB

MT20H682BB-*¹

Frequency (Hz) ²	125	250	500	1000	2000	4000	8000
Mean Attenuation (dB) ³	16.6	16.8	27.4	32.1	33.1	33.0	36.1
Standard Deviation (dB) ⁴	1.8	2.3	2.2	2.1	3.2	2.9	3.2
Assumed Protection Value (dB) ⁵	14.8	14.5	25.2	30.0	29.9	30.1	32.9

According to EN352-1:2002

SNR=28dB H=31dB M=25dB L=18dB

MT20H682FB* in combination with 3M EAR Classic earplug (EAR Plug mode)

Frequency (Hz)	63	125	250	500	1000	2000	4000	8000
Mean Attenuation (dB)	33.6	35.5	40.8	51.4	44.7	37.0	48.1	44.8
Standard Deviation (dB) ⁴	4.4	5.8	5.0	6.6	4.8	3.6	4.9	4.8
Assumed Protection Value (dB) ⁵	29.1	29.7	35.8	44.9	40.0	33.5	43.3	40.0

According to EN352-1:2002

SNR=39 db H=36 db M=38 db L=36 db



and





ComTac Headset Solutions

Communication made easy...

The dynamic microphone has a small coil attached to the membrane. When sound waves make contact with the diaphragm, it vibrates. As the coil is attached to the membrane, a small voltage is generated in it by electromagnetic induction. These microphones are “self driven” and need no external power source. The optimal positioning is 3-5mm from the lips.

The standard boom microphone is an ambient noise cancelling dynamic microphone with standard performance, which makes the systems usable for many purposes, such as radio and amplifier installations in aircraft, ships and vehicles or other places where noise levels are high.

The Gooseneck microphone has a flexible arm.

The throat microphone can be connected to detachable dynamic microphone input. Works well with gasmasks and respirators.



Standard Boom microphone



Flexi boom microphone



Throat microphone

3M™ PELTOR™ Products ComTac Headset Solutions



PELTOR™

3M™ PELTOR™ ComTac XPI Headset Electronic Level Dependent Headset



- Hearing protection
- Detachable microphone
- Level-dependent function for ambient listening
- "Plug and play", no start up time
- Foldable headband for easy storage and transport
- Configuration menu with voice guide
- Functions: release time, balance, external mute mode, EQ mode
- Earplug mode (maintains situational awareness when used in combination with earplugs)
- SNR 39 dB when combined with earplugs
- Automatic power off after two hours if no function is used
- No software loads or outside power required, complete selfcontained headset with power fail safe
- Tested according to military standards
- ~ 200h (battery & temperature dependent)

3M™ PELTOR™ wired Headset

Description

ComTac XPI Headset J11, Green
ComTac XPI Headset J11, Black
ComTac XPI Headset J11 Neckband, Green
ComTac XPI Headset J11 Neckband, Black
ComTac XPI Headset J11 Helmet Attach, Green
ComTac XPI Headset J11 Helmet Attach, Black
ComTac XPI Headset J11 goose-neck mic. Green
ComTac XPI Headset J11 goose-neck mic. Black

3M product code

UU001501269
UU001501053
UU001501053
UU001501061
UU001501293
UU001501301
UU001501103
UU001501814

Reference Id

MT20H682FB-38
MT20H682FB-38 SV
MT20H682BB-38
MT20H682BB-38 SV
MT20H682P3AD-38
MT20H682P3AD-38 SV
MT20H682FB-68
MT20H682FB-68 SV

Attachment

Foldable Head band
Foldable Head band
Neckband
Neckband
Helmet attach.
Helmet attach.
Foldable Head band
Foldable Head band

NATO wired Headset

Description

Headset J11, "NATO" wiring
Headset Black J11, "NATO" wiring
Headset J11, Neckband "NATO" wiring
Headset with rails attachment for example OPS-core helmet, "NATO" wiring
Headset w flexi boom mic, "NATO" wiring
Headset for double communication w flexi boom mic, "NATO" wiring

3M product code

XH001680913
XH001681036
UU001501079
XH001681044
XH001681051
UU001501087

Reference Id

MT20H682FB-86
MT20H682FB-86 SV
MT20H682BB-86
MT20H682P3AD-86
MT20H682FB-87
MT20H682FB-19B

Attachment

Foldable Head band
Foldable Head band
Neckband
Helmet attach.
Foldable Head band
Foldable Head band

MT20H682FB-^{*1}

Frequency (Hz) ²	125	250	500	1000	2000	4000	8000
Mean Attenuation (dB) ³	11.5	17.9	27.8	30.0	32.1	36.2	40.3
Standard Deviation (dB) ⁴	2.5	2.7	1.8	2.3	3.0	2.0	3.1
Assumed Protection Value (dB) ⁵	9.0	15.3	25.9	27.7	29.1	34.2	37.2

According to EN352-1:2002

SNR=28dB H=31dB M=25dB L=16dB

MT20H682BB-^{*1}

Frequency (Hz) ²	125	250	500	1000	2000	4000	8000
Mean Attenuation (dB) ³	16.6	16.8	27.4	32.1	33.1	33.0	36.1
Standard Deviation (dB) ⁴	1.8	2.3	2.2	2.1	3.2	2.9	3.2
Assumed Protection Value (dB) ⁵	14.8	14.5	25.2	30.0	29.9	30.1	32.9

According to EN352-1:2002

SNR=28dB H=31dB M=25dB L=18dB

Difference between "NATO and "PELTOR" Standard

"NATO" wiring

"PELTOR" STAND wiring

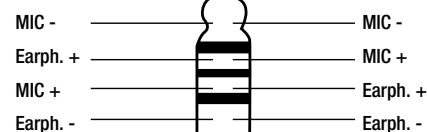



3M™ PELTOR™ Products

ComTac Headset Solutions



PELTOR™

3M™ PELTOR™ ComTac XPI Headset

Electronic Level Dependent Headset with Bone Conduction Microphone



MT20H682FB-69

- Hearing protection
- Detachable microphone
- Level-dependent function for ambient listening
- “Plug and play”, no start up time
- Foldable headband for easy storage and transport
- Configuration menu with voice guide
- Functions: release time, balance, external mute mode, EQ mode
- Earplug mode (maintains situational awareness when used in combination with earplugs)
- SNR 39 dB when combined with earplugs
- Automatic power off after two hours if no function is used
- No software loads or outside power required, complete selfcontained headset with power fail safe
- Tested according to military standards
- ~ 200h (battery & temperature dependent)

Description

ComTac XPI Headset with bone conduction mic. for SELEX PRR radio, Green

3M product code

XH001681002

Reference Id

MT20H682FB-69

Attachment

Foldable head band

Direct leed Headset for SELEX PRR radio

Description

ComTac XPI Headset for Selex PRR, Flexiboom mic
ComTac XPI Headset for Selex PRR, with MT7N mic

3M product code

UU001501848

Reference Id

MT20H682FB-89
MT20H682FB-90

Attachment

Foldable head band
Foldable head band

MT20H682FB-*

Frequency (Hz) ²	125	250	500	1000	2000	4000	8000
Mean Attenuation (dB) ³	11.5	17.9	27.8	30.0	32.1	36.2	40.3
Standard Deviation (dB) ⁴	2.5	2.7	1.8	2.3	3.0	2.0	3.1
Assumed Protection Value (dB) ⁵	9.0	15.3	25.9	27.7	29.1	34.2	37.2

According to EN352-1:2002

SNR=28dB H=31dB M=25dB L=16dB



ComTac IV Hybrid Headset

3M introduces the innovative 3M™ PELTOR™ ComTac 4 Hybrid Headset for today's modern warfighter. The 4th generation headset continues the legacy and tradition of trusted hearing protector headsets from 3M's PELTOR brand. The hybrid approach addresses customer demand for in-ear hearing protection while retaining the advantages of the traditional architecture of an over-the-ear style hearing protector.



3M™ PELTOR™ Products ComTac Headset Solutions



PELTOR™

3M™ PELTOR™ ComTac IV Headset Hybrid Headset

The 3M™ PELTOR™ ComTac IV is designed to help reduce exposure to hazardous levels of noise, improve situational awareness and at the same time enable two-way radio communication in noisy environments.



- Designed for comfortable use with a ballistic helmet
- Hearing protection
- Detachable microphone & ear buds
- Backwards compatible with 3M™ PELTOR™ FL50** series adapters
- Level dependent function for situational awareness
- Easy to use and operate
- Foldable for easy storage and transportation
- Voice guided configuration menu
- Functions: release time, balance, boost mode
- Automatic switch off after two hours if no function is used
- Headset electronics are contained completely inside the headset housing, eliminating the need for a large, heavy external radio control box
- A headband which mechanically stabilizes the headset to help relieve issues of earplugs dislodging from cable snages and body movement
- No software loads or outside power required, complete self-contained headset with power fail safe
- Tested to military standards

Description

ComTac IV Headset, standard wired J11, Green
ComTac IV Headset, NATO wired J11, Green
Comtac IV Headset, Stereo connected J11 Green

3M product code

XH001679535
XH001679543
XH001679550

Reference Id

MT16H044F-38 GN
MT16H044F-86 GN
MT16H044F-88 GN

Attachment

Foldable head band
Foldable head band
Foldable head band

Accessories and Spare parts:

Description

Flexi boom speech microphone
Throat microphone (dynamic)
Battery lid
Wind protection foam
Comfort padding-foam
Pair of ear buds
Ultrafit eartips, 50 pairs
Torque eartips, 50 pairs

3M product code

UU001501863
XL001644068
11003065544
XH001652532
XH001679584
XH001679600
XH001679618
XH001679626

Reference Id

MT31E/1
MT90-02
1079 S
M60/2
HY700
HTM045/2
PELTIP4-01
PELTIP5-01

HY700

Comfort padding - foam



HTM045/2

Pair of ear buds



MT31E/1

Flexi boom speech microphone



M60/2

Wind protection foam



PELTIP4-01

Pair of ear Ultrafit ear tips



PELTIP5-01

Pair of ear Torque ear tips



MT90-02

Throat microphone (dynamic)



1079 SV

Battery lid



PELTIP4-01 in combination with MT16H044F-** UltraFit Eartips

Frequency (Hz)	125	250	500	1000	2000	4000	8000
Mean Attenuation (dB)	28.6	27.0	30.3	29.2	30.9	31.6	32.0
Standard Deviation (dB)	5.3	6.0	6.0	5.4	3.4	6.6	4.5
Assumed Protection (dB)	23.3	21.0	24.4	23.8	27.4	25.1	27.6

According to EN352-1:2002

SNR=27dB H=26dB M=25dB L=23dB

PELTIP5-01 in combination with MT16H044F-** Torque Eartips

Frequency (Hz)	125	250	500	1000	2000	4000	8000
Mean Attenuation (dB)	31.0	29.5	31.4	33.9	33.7	40.0	42.4
Standard Deviation (dB)	4.9	4.6	5.2	5.5	3.6	2.5	3.4
Assumed Protection (dB)	26.1	24.9	26.3	28.4	30.1	37.4	38.9

According to EN352-1:2002

SNR=32dB H=32dB M=29dB L=27dB



Tactical Solutions

The 3M™ PELTOR™ Tactical Product range includes invaluable tools for people who are subjected to impulse noises. 3M™ PELTOR™ Tactical Products help protect against harmful noise while letting in and even sometimes amplifying ambient sounds.



PELTOR™

3M™ PELTOR™ SportTac™ Headset Electronic Level Dependent Hearing Protector



MT16H210F-478-GN

- Developed specifically for hunters and marksmen
- Smooth level dependent function, which eliminates abrupt sound cut-off
- Interchangeable shells makes it easy to change colour
- Equipped with automatic shut-off function
- Collapsible for easy storage
- Not to be used in combat situations
- Does not fit under a ballistic helmet

Does not fit under ballistic helmet!

Description

Hunting, orange shells incl. Green / Orange
Sport shooting, black shells incl. Black / Red

3M product code

XH001650049
XH001650056

Reference Id

MT16H210F-478-GN
MT16H210F-478-RD

Attachment

Foldable head band
Foldable head band

MT16H210F-478-GN

Frequency (Hz)	125	250	500	1000	2000	4000	8000
Mean Attenuation (dB)	12.1	17.9	27	26.8	30.5	38.3	36.4
Standard Deviation (dB)	4.3	3.1	3.8	3.0	3.0	3.7	5.4
Assumed Protection (dB)	7.8	14.8	23.2	23.8	27.5	34.6	31

According to EN352-1:2002

SNR=26dB H=29dB M=23dB L=16dB

3M™ PELTOR™ WS™ SportTac™ Headset Electronic Level Dependent Hearing Protector with Bluetooth® Wireless Technology



3M™ PELTOR™ WS™ SportTac™ Level dependent Hearing Protector allows you to better control what you hear – and don't hear. You can easily adjust the volume of surrounding sounds, filter out certain unwanted frequencies and still be protected from harmful noise levels when the shot is taken. The built in **Bluetooth®** solution makes it possible for wireless connection to a mobile phone or other communication device for instant and discreet communication.

Does not fit under ballistic helmet!

Description

WS SportTac, Green

3M product code

XH001676184

Reference Id

MT16H21FWS5E-584GN

Attachment

Foldable head band

MT16H21FWS5E-584GN

Frequency (Hz)	63	125	250	500	1000	2000	4000	8000
Mean Attenuation (dB)	15.1	11.1	18.2	27.0	23.8	33.4	37.7	38.8
Standard Deviation (dB)	3.8	2.6	2.3	2.2	2.1	3.6	2.2	3.3
Assumed Protection (dB)	11.4	8.5	15.9	24.8	21.7	29.8	35.5	35.5

According to EN352-1:2002

SNR=26dB H=29dB M=23dB L=17dB



PELTOR™

3M™ PELTOR™ Tactical™ XP Headset Electronic Level Dependent Hearing Protector



MT1H7F2

- Level dependent function that lets you hear ambient sound: conversation, machine sounds and warning signals
- Electronic voice guided menu system
- Equipped with the following functions: volume for the level dependent function, balance, adjustable release time, equalizer, volume for external input and external input mode
- Plenty of space for the ear
- Last setting is stored when switched off
- Automatic shut-off after two hours if no function is used
- Warning signal when power is low, before shut-off
- Audio input jack for external radio
- Available as headset

Description

Tactical XP, Standard
Tactical XP, Headset J11

3M product code

XH001650064
XH001660717

Reference Id

MT1H7F2
MT1H7F2-07

Attachment

Foldable head band
Foldable head band

MT1H7F2

Frequency (Hz)	125	250	500	1000	2000	4000	8000
Mean Attenuation (dB)	13,8	21,5	30,9	36,6	35,9	35,5	39
Standard Deviation (dB)	1,8	0,9	1,3	1,5	5,5	3,1	2,3
Assumed Protection (dB)	12,0	20,6	29,6	35,1	30,4	32,4	36,7

SNR=31dB H=32dB M=29dB L=20 dB

3M™ PELTOR™ ProTac II Headset Electronic Level Dependent Hearing Protector



MT15H7A2 GN

- Improves communication in noisy environments
- Level dependent function in stereo that lets you hear ambient sound: conversation, machine sounds and warning signals
- Plenty of space for the ear
- Last setting is stored when switched off
- Headset option with guide-mounted microphone
- Three colour options: Military green, Red, Black
- Automatic shut-off after two hours if no function is used
- Battery life is about 1000 hours. Warning signal when power is low, before shut-off
- Audio input jack for external radio

Description

ProTac II, Standard, Green
ProTac II, Standard, Black

3M product code

XH001650015
XH001650031

Reference Id

MT15H7A2 GN
MT15H7A2 SV

Attachment

Head band
Head band

MT15H7A2

Frequency (Hz)	125	250	500	1000	2000	4000	8000
Mean Attenuation (dB)	13,8	21,5	30,9	36,6	35,9	35,5	39
Standard Deviation (dB)	1,8	0,9	1,3	1,5	5,5	3,1	2,3
Assumed Protection (dB)	12,0	20,6	29,6	35,1	30,4	32,4	36,7

SNR=31dB H=32dB M=29dB L=20 dB



3M™ PELTOR™ TEP-100 Tactical Earplug

Electronic Level Dependent Hearing Protector

PELTOR™



The 3M™ PELTOR™ TEP-100 Tactical Earplug helps provide hearing protection, and helps improve situational awareness and communication. The small, lightweight, and rechargeable tactical earplugs are designed for tactical, engineering, and maintenance applications.

Communication

3M™ PELTOR™ level-dependent technology helps provide hearing protection in noise and improves communication in quiet. Protecting hearing and improving situational awareness can help increase safety and improve productivity.

Compatibility

3M™ PELTOR™ Tactical Earplug is compatible with most headborne 3M™ Personal Protective Equipment (PPE) such as helmets, hardhats, and face shields.

Comfort

The small and lightweight design helps improve overall comfort and user experience.

3M™ PELTOR™ OraTac Headset

Electronic Level Dependent In-Ear headset

3M™ PELTOR™ OraTac Headset is a dual sided in-ear headset. It helps provide clear communication with level dependent function (similar to situational awareness) when attached to your 2 way radio.

It helps provide protection from high-noise in a variety of environments and helps provide protection from impulse noises when they occur. The OraTac system is comprised of an in-ear headset with PTT adapter and a quick disconnect cable. The cable connects to individual radios and can be switched when a new radio is purchased.

- Hearing protection
- Level dependent function provides situational awareness
- Lightweight and compact
- In-ear microphone eliminates the need for a boom mic
- Quick radio connect/disconnect



Description	3M product code	Reference Id	Attachment
In-Ear headset	XH001679295	MT10FL10	In-Ear headset

For more information about the existing cable to radios, please contact your 3M contact in your Country.





Mission Essential Products

3M™ PELTOR™ and 3M™ E-A-R™ Products help provide the appropriate equipment regardless your mission. From the 3M™ E-A-R™ Classic™ Earplug for attenuation and comfort, to complex communication systems adapted for army, navy and airforce.



Adapters & Cables

Sturdy, water-resistant adapters with integrated push-button (PTT) for connecting 3M™ PELTOR™ Headsets to communication radios and mobile telephones. For environments with risk of explosion, we also have ATEX-approved EX adapters.



3M™ PELTOR™ Products Customized Adapters



PELTOR™

3M™ PELTOR™ Adapter Single PTT FL5000

The 3M™ PELTOR™ Adapter FL5000 series is a small, strong and easy-to-handle adapter, specially designed for rough environments. The PTT button is within easy reach, both from the right and left hand side, and easy to handle even when wearing heavy gloves. The adapter, and the jack, in particular, have been designed to protect the electronic components against moisture. The chassis jack and strain-relief have been tested and approved for a min. of 100,000 plug-ins. The back of the adapter has a strong, 360° turnable clip for secure fastening on garments.



FL5000

3M™ PELTOR™ Adapter Single PTT FL4000

The 3M™ PELTOR™ Adapter FL4000 series is a small, strong and easy-to-handle adapter, specially designed for rough environments. The PTT button is within easy reach, both from the right and left hand side, and easy to handle- even when wearing heavy gloves. The adapter, and the jack, in particular, have been designed to protect the electronic components against moisture. The chassis jack and strain-relief have been tested and approved for a min. of 100,000 plug-ins. The back of the adapter has a strong, 360° turnable clip for secure fastening on garments.



FL4000

3M™ PELTOR™ Adapter Multi PTT

Special adapters for special needs.
It's possible to choose if the headset shall have a connector or not.

Two radios at the same time with the dual radios connectors and PTT button for each radio.



FL5600



FL5700

3M™ PELTOR™ Products Military Solutions



PELTOR™

Standard Adapters

Communication radio	3M product code	Reference Id
ICOM IC, Alan, Zodiac (straight connector), Yaesu, Alinco	XH001650999	FL5010
Motorola GP900, HT1000, MT2000	XH001651914	FL5018
Motorola GP340, GP320	XH001651005	FL5030
ICOM IC-F3GS, IC-F3GT, IC-F4GS, IC-F4GT (angled connector)	XH001651013	FL5034
Kenwood TK3101, Funkey	XH001651021	FL5035
Nokia TETRA THR880/ EADS TETRA THR880i	XH001654249	FL5042
ICOM F31/F41 F51/F61	XH001654256	FL5044
Sepura TETRA SRP2000 / SRH3*00	XH001654280	FL5058
Sepura TETRA STP8000 series	XH001675269	FL50101
Motorola TETRA MTP850	XH001654306	FL5062
Motorola TETRA MTH800	XH001677794	FL50-T9170
Motorola Mototrbo	XH001654314	FL5063
ICOM IC-M1 / M71	XH001654348	FL50-T9088
ICOM IC-A3, A4, A6 / A22	XH001654389	FL50-T9089A
ICOM IC-F34/F44	XH001654397	FL5064
Vertex VX 160 / 400	XH001654405	FL50-T9140
Motorola GP344 / 388	XH001654413	FL5065
Vertex VX 820, 920	XH001654447	FL5043
Vertex HX370	XH001664974	FL50-T9150
Cassidian EADS THR9	XH001679188	FL40142
Motorola GP340, GP320	UU001512910	FL4030
Motorola Mototrbo	UU001512936	FL4063
Shroud for FL50**, FL55**, FL56**	XH001652946	TKD5502/1



FL5000



FL4000



TKD5502/1

Adapters for Military radios, “PELTOR” wiring

Communication radio	3M product code	Reference Id
Adapter for MBITR 2M, AN/PRC-148	XH001654223	FL5040
Thales PR4G	XH001654272	FL5052
Adapter for RA145, RA146, RA180 (for Sweden)	XH001654140	FL5025
Adapter for MBITR 20M, Maritime	XH001654462	FL50-T9507

Headset and Adapters for Military radios, “NATO” wiring

Communication radio	3M product code	Reference Id
Adapter for MBITR 2M, AN/PRC-148, “NATO” wiring	XH001665120	FL5040-07
Adapter for Motorola GP340	XH001678214	FL5030-02
Adapter for Harris 7800, J11, “NATO” wiring	XH001678388	FL5601-100
Adapter for MBITR 2M, AN/PRC-148, “NATO” wiring		FL4040-02

For more information regarding adapters for military radios, please contact your 3M military sales representative in your country.

Stereo connected Headset and Adapters for Military radios

Description	3M product code	Reference Id
Headset Stereo connected J11, with MT7N mic. (Only for FL5501 and FL5701 adapter)	XH001680897	MT20H682FB-88
Dubble adapter for MBITR 2M, AN/PRC-148 (Only to MT20H682FB-88 Headset)	Special Made	FL5501
Dubble adapter for MBITR 2M, AN/PRC-148 (Only to MT20H682FB-88 Headset)	XH001673611	FL5701

3M acknowledges the respective Trademark Owner's rights in the above trademarks

For more information regarding adapters for military radios, please contact your 3M military sales representative in your country.







3M™ PELTOR™ Products Spare Parts & Accessories



PELTOR™



M42/1



HY79
NSN number: 5965-66-146-0146



HYM1000



MT7N



M60/2



MT31E/1 Short cable
MT31E Long cable for Neck band Headset



FL6AB
NSN number: 5995-25-148-1859



MT90-02 Dynamic mic
MT90-06 Electret mic



FL6AC
NSN number: 5995-25-148-9238



M995



MT90H044

3M™ PELTOR™ Vehicle Intercom T8034A

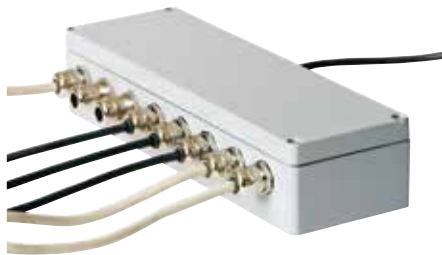

T8034A

- The 3M™ PELTOR™ Vehicle Intercom is an intercom system based on 3M™ PELTOR™ Rally Amplifiers
- The system is designed for use in vehicles on land and sea, combining full-duplex communication with connectivity to a mobile station/com radio(s)
- The vehicle intercom system is fitted in a moisture and impact-resistant metal capsule (IP65)
- Cables for power, headsets, PTT function and mobile stations can be connected to the unit

Description

Max. 4 users, power supply 12V
Headset with J47 contact, (MT7H79A-T5086G)
Aviation-Headset, 2m cable with VK01 & J47 contact
(MT51H79F-T5086P)

3M product code

XH001662374
Special Made
Special Made

Reference Id

T8034A
PPN:
PPN:

Plastic Headsetbox for 1 headset, 5m cable, J47C
Aluminium Headsetbox for 1 headset, 5m cable, J47C
Plastic Headsetbox for 3 headset, 5m cable, J47C
PTT button with 2m cable
FL500 Adapter for Peltor J11 contact to Vehicle Intercom
FL400 Adapter for Peltor J11 contact to Vehicle Intercom

Special Made
Special Made
Special Made
XH001662770
XH001654330
Special Made

PPN: 14-0022
PPN:14-0043
PPN:03-0108
TA007
FL50-T9081
PPN: 14-0090

Exampel on wiring diagram.

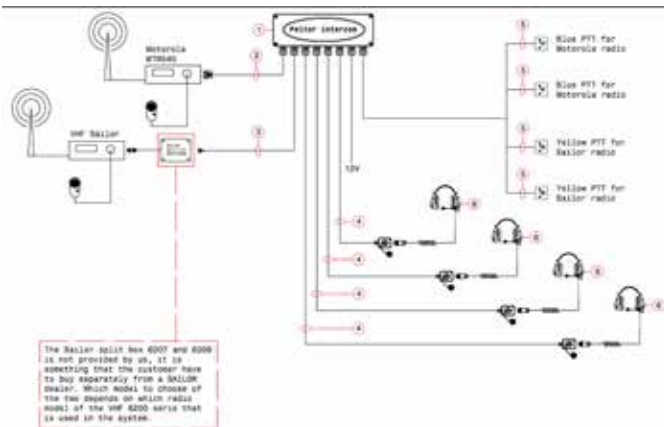

For more information please contact the 3M™ Technical Service in Värnamo.





PELTOR™

3M™ PELTOR™ LiteCom Plus Headset

Built-in Two-way Radio Headset



MT7H7A4410-EU

- Available in two versions; with 8 channels in the PMR 446 MHz band or with 69 channels on the LPD 433 MHz band (A users license may be required)
- On the PMR channels 38 subchannels allow several user groups to communicate without listening to other groups on the same channel
- Built-in active-sound function lets you hear ambient sounds; warning signals, machine sounds, conversation etc, while sudden impulse noise at harmful levels are immediately attenuated
- An electronic voice in the receiver tells you the settings of the device
- Separate PTT button for the auxiliary input, where a cellular phone, a com. radio, or other audio source can be connected
- Unused, the headset switches off automatically to save the batteries

Description

LiteCom Plus, PMR 446
LiteCom Plus, LPD 433

3M product code

XH001680467
XH00168049

Reference Id

MT7H7A4410-EU
MT7H7A4310-EU

Attachment

Head band
Head band

MT7H7A4410-EU, MT7H7A4310-EU

Frequency (Hz)	63	125	250	500	1000	2000	4000	8000
Mean Attenuation (dB)	21.2	20.2	26.7	35.0	37.4	35.7	40.4	38.9
Standard Deviation (dB)	4.1	3.1	3.1	2.6	2.1	3.0	2.9	2.1
APV (84%)*	17.1	17.1	23.6	32.4	33.3	32.7	37.5	36.8

* Assumed Protection Value (dB)

SNR=34 db H=35 db M=32 db L=25 db

3M™ PELTOR™ WS™ LiteCom Headset

Built-in Two-way Radio Headset and Bluetooth® Wireless Technology



3M™ PELTOR™ LiteCom Communication Headsets have a communication radio built into a highly attenuating ear protection. In the WS headset, there is also a **Bluetooth®** link for connecting the headset to a mobile phone or another audio device with **Bluetooth®** functionality. Stereo microphones pick up the ambient sound which is reproduced inside the shells, while a level dependent surround sound function is effectively limiting impulse sounds to avoid hearing damage.

Included in the package

3M™ PELTOR™ WS™ LiteCom Headset
Rechargeable battery
Alkaline batteries
Hygiene kit

Description

WS Lite-Com™, PMR 446 MHz

3M product code

XH001677026

Reference Id

MT53H7A4410WS5

Attachment

Head band

MT53H7A4410WS5

Frequency (Hz)	63	125	250	500	1000	2000	4000	8000
Mean Attenuation (dB)	18.3	14.7	23.4	30.7	34.6	34.5	36.9	37.3
Standard Deviation (dB)	5.0	3.9	4.6	3.2	3.4	3.1	2.7	4.2
APV (84%)*	13.3	10.8	18.8	27.4	31.2	31.4	34.2	33.1

* Assumed Protection Value (dB)

SNR=30 db H=33 db M=27 db L=19 db



PELTOR™

3M™ PELTOR™ WS™ ProTac XP™ Headset Bluetooth® Wireless Technology Headset

The 3M™ PELTOR™ WS™ ProTac XP Headset is an active-hearing hearing protector that features **Bluetooth®** technology. The **Bluetooth®** function enables work with both hands free while taking calls via DECT- or mobile phones. The ambient listening function lets the user hear surrounding noise and converse with colleagues. The headset helps provide effective noise attenuation when sound level is high.

- DSP (Digital Noise Reduction)
- Supports **Bluetooth®** functionality A2DP profile for streaming high quality stereo sound
- Advanced VOX (Voice Operated Transmit)



Description	3M product code	Reference Id	Attachment
WS ProTac XP headband	XH001680012	MT15H7AWS5	Head band
WS ProTac XP helmet attachment	XH001680004	MT15H7P3EWS5	helmet attachmen
WS ProTac XP neckband	XH001680335	MT15H7BWS5	neckband

MT15H7AWS5**

Frequency (Hz)	63	125	250	500	1000	2000	4000	8000
Mean Attenuation (dB)	19.2	17.4	24.0	31.9	34.4	35.1	37.0	35.1
Standard Deviation (dB)	4.0	2.8	2.9	3.0	2.6	4.3	4.0	3.2
APV (84%)*	15.2	14.5	21.1	28.9	31.9	30.8	33.1	32.0

* Assumed Protection Value (dB)

SNR=31 db H=32 db M=29 db L=22 db

MT15H7P3EWS5**

Frequency (Hz)	63	125	250	500	1000	2000	4000	8000
Mean Attenuation (dB)	17.2	18.6	23.2	30.8	35.4	35.5	37.0	34.2
Standard Deviation (dB)	3.8	2.7	2.7	4.4	2.5	4.2	3.2	3.7
APV (84%)*	13.4	15.9	20.4	26.3	32.9	31.2	33.8	30.5

* Assumed Protection Value (dB)

SNR=31 db H=32 db M=29 db L=22 db

MT15H7BWS5**

Frequency (Hz)	63	125	250	500	1000	2000	4000	8000
Mean Attenuation (dB)	17.0	15.6	21.8	30.8	32.7	33.6	36.4	34.9
Standard Deviation (dB)	3.8	3.8	3.5	2.9	2.9	2.5	3.3	2.4
APV (84%)*	13.2	11.8	18.2	27.9	29.8	31.1	33.1	32.4

* Assumed Protection Value (dB)

SNR=30 db H=32 db M=27 db L=19 db

3M™ PELTOR™ WS™ Headset Bluetooth® Wireless Technology Adapter

3M™ PELTOR™ WS™ Industrial Adapter has a built-in **Bluetooth®** function that allows for complete wireless connection between a 2-way radio and a PELTOR WS headset. When used with the PELTOR WS headset XP or the WS ProTac XP headset, the functions advanced VOX and DSP are available, which gives good sound quality and clear communication.

Description	3M product code	Reference Id
WS5 Flex Adapter	XH001680327	FL6077-WS5
WS5 Adapter for Motorola GM350 mobile station	XH001680285	FL6060-WS5

Application

The PELTOR™ WS™ Industrial Adapter can be used with a wide range of PELTOR WS headsets to connect to a 2-way radio. For all non-explosive environments.



For more information about the existing cable to radios, please contact your 3M sales rep in your Country.



Helmet Solutions

Combat helmets meeting the military's rigorous ballistic and fragmentation requirements at a significantly lower weight.

Ceradyne, Inc., a 3M company

Soldier Protection Systems



3M™ Ultra light Weight Ballistic Bump Helmet (ULW-BBH)

Engineered to help provide outstanding head protection, 3M™ Ultra Light Weight Ballistic Bump Helmets (ULW-BBH) are the first multi-use helmet for bump, jump and ballistic operational requirements. The combination of advanced materials with 3M's unique processing technology provides ballistic, fragmentation and blunt impact protection at a significantly lower weight than the closest alternative. They are available in a range of sizes and colors, and are configurable with optional accessories for a variety of multi-mission requirements.

Controlled by the US Department of Commerce



3M™ Combat High Cut Ballistic Helmet

Manufactured with similar dimensions to the U.S. military ACH helmet, 3M™ Combat High Cut Ballistic Helmets are lighter in weight, while still providing a high level of ballistic protection. They also feature a higher cut for unobstructed views and increased hearing capabilities compared to the PASGT helmet. The neck trim line provides maximum protection, while allowing uninhibited movement when wearing most ballistic vests with collars. Available in a range of sizes and colors, all 3M combat high cut ballistic helmets are configurable with optional accessories for multi-mission requirements.



3M™ Combat Ballistic Helmet

Although their dimensions are similar to the U.S. military ACH helmet, the thermoplastic aramid and glass fabric composite construction of 3M™ Combat Ballistic Helmets makes them lighter in weight, while still providing a high level of ballistic protection. Its design provides optimal sight and hearing capabilities, while the neck trim line allows for uninhibited movement when wearing most ballistic vests with collars. The entire helmet is finished with an extruded neoprene rubber trim and protected with scratch-resistant, non-reflective flat paint.



Export Control. The Ceradyne product(s) listed here may be controlled commodities under applicable U.S. export control laws and regulations, including, but not limited to, the U.S. International Traffic in Arms Regulations (ITAR) and the Export Administration Regulations (EAR). These laws and regulations may, among other things, prohibit the export and/or reexport of controlled product(s) to any or all locations outside of the United States without prior U.S. Government export authorization, the sharing of export controlled technical data and services with those anywhere who are not U.S. citizens or U.S. permanent residents, dealings with U.S. Government, United Nations and other "Restricted Parties," and proliferation activities including those that further nuclear, chemical, or biological warfare, missile stockpiling/use, or the use of rockets or unmanned aerial vehicle systems. Ceradyne and purchasers or prospective purchasers of the Ceradyne product(s) shall comply with all applicable export control laws and regulations, which may require obtaining and maintaining applicable export control authorization or licenses, and understand that the ability of a party to obtain or maintain such authorization or license is not guaranteed. The exporter of record has the sole responsibility to determine whether the export or subsequent reexport of the Ceradyne product(s) requires export authorization. An explicit condition to Ceradyne selling or making available the Ceradyne product(s) is the customer's agreement to comply with all applicable trade compliance laws and regulations.

For more information regarding the helmets, please contact your 3M military sales representative in your country.



Eyewear Solutions

The premium range of safety spectacles offers the highest optical class. A broad range of eyewear products include durable anti-scratch and convenient anti-fog coatings. Most of the safety spectacles and goggles by 3M offer reliable UV protection and are all approved to EN166:2001 and are CE marked.

All eyewear products displayed in this catalogue are specially made for Military & Police, and are tested according to STANAG 2920 (Edition 2) test regime for high velocity impact protection. (Not listed or certified by QPL/QML)



3M™ Maxim™ Ballistic TacPack



Description	3M product code	Reference Id
Maxim Ballistic TacPack	DE272933560	13204-99999M
Insert	70071530656	40719-00000

PACK CONTENT

- 1x protective hardcase
- 1x black microfiber pouch
- 1x Spectacle with clear anti-fog lens and straight temples
- 1x Replacement elastic black headband
- 1x Amber anti-fog replacement lenses
- 1x Dark grey anti-fog replacement lenses

TESTED ACCORDING TO

- EN166 (impact protection: FT)
- STANAG 2920 (Edition 2), V₅₀ projectile A3/6723/6, 3.6 mm diameter , V₅₀ = 251 m/s (not listed or certified by QPL/QML)

CASE AND POUCH

- Rigid case with zipper, 40mm belt loop and plastic snap clasp
- Place to put the spectacle, 2 replacement lenses, 1 elastic headband and 1 microfiber pouch
- Soft black microfiber pouch suitable to clean the lens

SPECTACLE

- Plastic frame with DuoForm mould processing
- Dual injected cushion browguard
- Soft universal-fit nose bridge pivots
- Ventilation channel on the top to help prevent fogging
- Short flat replacement temples for better fit under helmets and cups
- By rotating and removing the temples, the various lenses can be replaced with ease
- Broad adjustable elastic strap for secure fit (removable)

LENSES

- Polycarbonate patented aspherical lens (better coverage and excellent field of vision)
- Optical quality class 1 (no distortion)
- Resistance to impact at extreme temperature (marking FT)
- DX coating anti-fog, anti-scratch, anti-static and anti-chemical attack
- Clear lens for indoor use. VLT = 88%
- Amber lens for low light condition VLT = 88% (cloudy environment) (enhance the contrast and luminosity).
- Dark grey lens for outdoor use (sunny condition) VLT = 13%
- All lens colour provide UV-protection according to EN 170 or EN 172, depending on the lens colour.



3M™ Sentinel™ TacPack



Description	3M product code	Reference Id
Sentinel TacPack	DE272934345	71510-00003M

LENSES

- Tough anti-fog and anti-scratch polycarbonate lenses
- Optical quality class 1 (no distortion) and UV protection
- Maxi-impact system: the lens can not be removed from the back side (impact resistance up to 168m/s)
- Dual-lenses for better orbital eye coverage and wide viewing range for weapons sighting
- Clear lens for indoor use. VLT = 90%
- Amber lens for low light condition (cloudy environment enhance the contrast and luminosity). VLT = 89%
- Grey lens for outdoor use (sunny condition). VLT = 11%
- All lens colour provide UV-protection according to EN 170 or EN 172, depending on the lens colour.

PACK CONTENT

- 1x protective case
- 1x black microfiber pouch
- 1x goggle with elastic strap with Clear lenses
- 1x comfortable ventilation insert
- 1x amber anti-fog replacement lenses
- 1x grey anti-fog replacement lenses

CASE AND POUCH

- Rigid case with zipper, 40mm belt loop and plastic snap clasp
- Place to put the goggle and 2 pairs of replacement lenses
- Soft microfiber pouch suitable to clean the lens

GOGGLE

- High impact nylon black frame for added durability (resistance to impact, heat and cold)
- Specially designed foam gasket is removable, shock resistant and complies with the ANSI flammability test
- Low profile design for better fit under helmets and for the use of army rifle
- Special ventilation system on the bottom and top for heat release and fog resistance
- Broad adjustable elastic strap for secure fit

TESTED ACCORDING TO

- EN166, field of Use 3, Impact rating FT
- STANAG 2920 (Edition 2), projectile A3/6723/6, 3.6mm diameter, V₅₀, 247 m/s (not listed or certified by QPL/QML)

3M™ Fahrenheit™ TacPack



Description	3M product code	Reference Id
Fahrenheit TacPack	DE272934204	71360-99999M

PACK CONTENT

- 1x protective hardcase
- 1x soft nylon case to store 2 cover lenses
- 1x Goggle with 2 single Clear lens bonded together
- 1x Lens cover to protect when not in use
- 1x Cover lens with holder, Amber tint (2C-1.2)
- 1x Cover lens with holder, Dark Grey tint (5-3.1)
- 1x Microfiber cleaning cloth 17,5cm x 17,5cm, washable

TESTED ACCORDING TO

- EN166, field of Use 3 & 4, Impact rating BT
- STANAG 2920 (Edition 2), projectile A3/6723/6, 3.6mm diameter, V₅₀, 250 m/s. (not listed or certified by QPL/QML)

GOGGLE FRAME

- Black TPU (Thermo Plastic Urethane) goggle with indirect ventilation system to prevent fog, dust, sand and liquid
- Thermoformed vented foam for extra comfort
- Temples include a channel to allow users to wear prescription spectacles under the goggle
- Large adjustable nylon head strap (38mm) with polyamide side attachment designed to fit over military helmet
- Silicone lines on the strap to avoid to slide along the helmet
- Frame design provides good coverage and good field of vision

BASE LENS: CLEAR DUAL PANEL LENS

- 2 single lens bonded together with a 2mm space between them to create a lative thermal barrier that keeps the inner lens warm and dry (best anti-fog system possible)
- Both lenses are in 1.2mm polycarbonate with anti-fog coating
- Optical quality class 1 (no distortion - marking 1)
- Resistance to impact at extreme temperature (marking BT @ 120m/s)
- UV filtration (in conformity with EN 170), marking 2C - 1,2
- Inner lens: anti-fog coating / Outside lens = anti-scratch
- Lens marking = 2C-1,2 3M 1 BT (VLT = 82%)
- "clip-on" easy cover lens installation.
- The lens cover can be installed even in the dark in a few seconds.



Advanced Optical Engineering by 3M



Advanced Optical Engineering is the true essence of 3M protective eyewear, taking into consideration design, protective qualities and comfort.

In 3M's world, premium is undisputed. Premium Lens Technology results in optimal optics with unobstructed field of vision. Premium Lens Technology gives wear with less eyestrain. Due to advanced optical engineering, 3M has developed patented innovative lens solutions, such as an aspherical lens featuring distortion free sight.

3M's capabilities also include Premium Coating Technology, which is evident in our proprietary 3M™ DX™ Coating.

DX-coating offers a unique formula for the four critical protective properties: anti-mist, abrasion resistance, anti-static and chemical resistance. The DX coating is continuously being developed and monitored in order to provide optimum performance.

3M's premium design may seem unimportant from a protective perspective. However, if eyewear is attractive and comfortable to wear, your staff will be encouraged to use it.

Advanced Optical Engineering makes 3M an excellent choice.

The unique aspherical lens by 3M



The Human Eye:

- **The Cornea:** in direct contact with external environment, plays an essential part on the transmission of light rays. It is the structure of the human body which has the highest tactile sensibility.
- **The Pupil:** (light controller), situated in the middle of the iris, works like the diaphragm of a camera. Its diameter changes in accordance with the luminosity.
- **The Lens** allows focusing (near vision, far vision) thanks to a control muscle. With age this muscle loses power and impacts near vision (presbyopia). The lens can lose its transparency due to exposure to IR (infrared light) and UV (ultraviolet light), resulting in loss of vision (cataract).
- **The Retina:** where all light beams converge, transmits all information through the optic nerve to the brain in order to create your vision. Burned retina cells are lost forever which cause irreversible loss of vision.

Potential Industrial hazards for the eyes:

- **Mechanical hazards:** dust, shock, solid particles.
- **Thermal hazards:** hot liquid, molten splash, flames.
- **Chemical or Biological hazards:** splashes for acids, solvents, alkalis, infected blood.
- **Radiation hazards:** ultraviolet, infrared, visible, light, laser.
- **Electrical hazards:** direct contact, short-circuit electric arc.

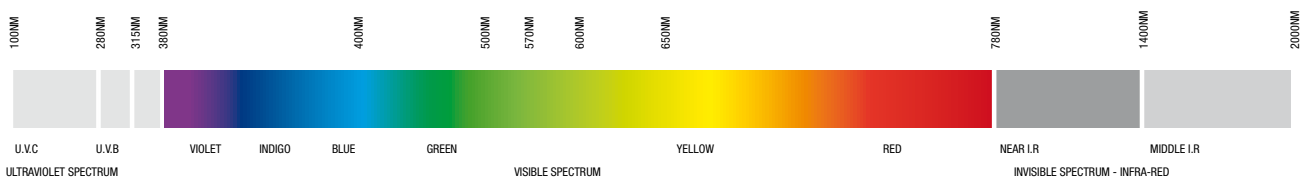
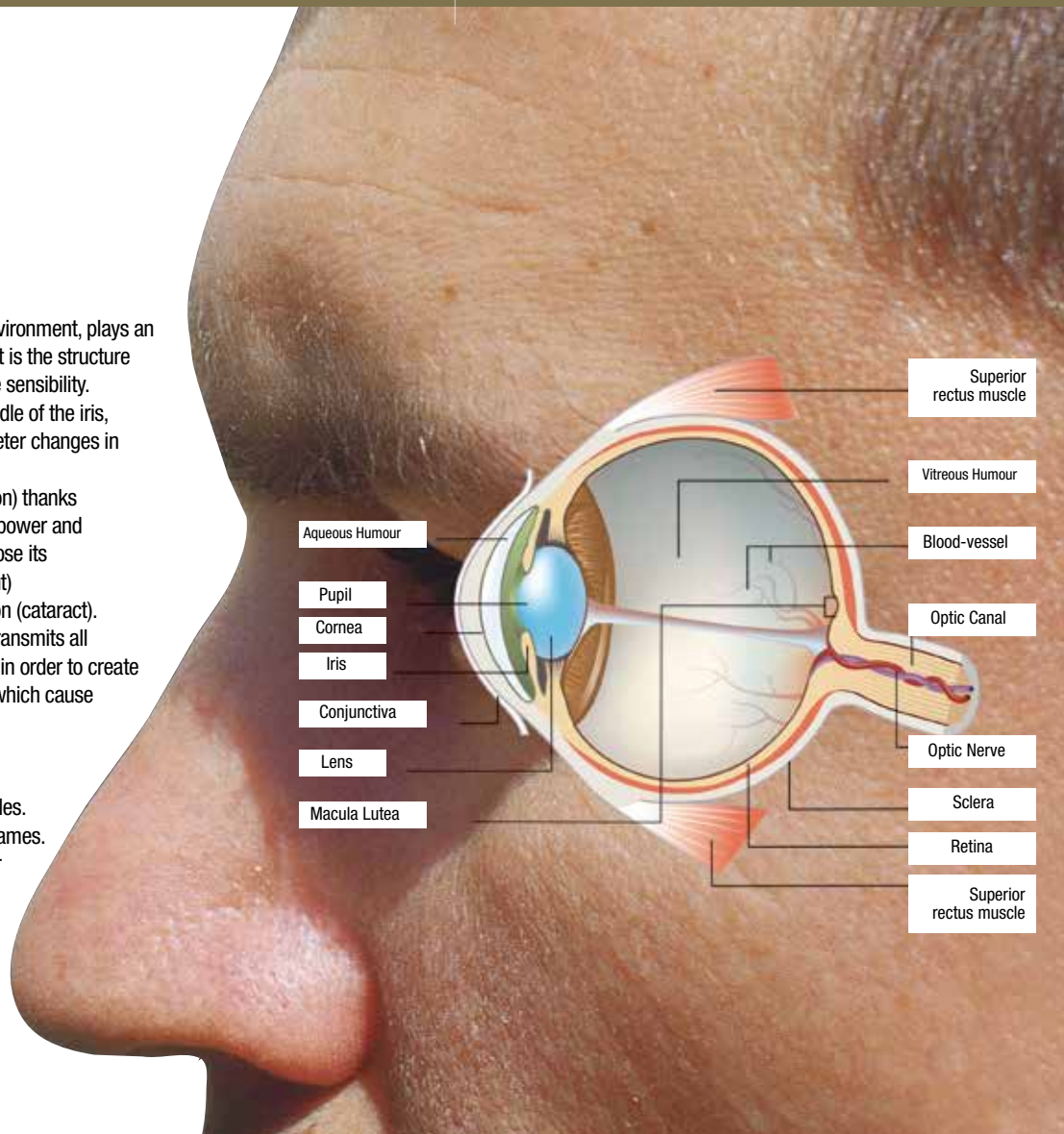

	U.V.C 100 TO 280NM	U.V.B 280 TO 315NM	U.V.A 315 TO 380NM	BLUE LIGHT 380 TO 480NM	VISIBLE LIGHT 380 TO 780NM	NEAR I.R. 780 TO 1400NM	MIDDLE I.R. 1400 TO 2000NM
CORNEA	CONJUNCTIVITIS PARTIAL BLINDNESS	CONJUNCTIVITIS PARTIAL BLINDNESS	CONJUNCTIVITIS PARTIAL BLINDNESS				
LENS		CATARACT PREMATURE AGING	CATARACT PREMATURE AGING			CATARACT	CATARACT PARTIAL BLINDNESS
RETINA				PARTIAL BLINDNESS PHOTORETINITIS	VISION PROBLEMS DISCONTINUOUS VISION	RETINIS PIGMENTOSA BLINDNESS	



Hearing Protection

Choosing the correct hearing protection is paramount to a successful hearing conservation programme. If you offer just one type of device, it will not suit all workers and you are more likely to get some workers not wearing their hearing protection.

However if you consult with your workers over the choice of hearing protection and offer a choice, for example a foam earplug, a banded hearing protector and an earmuff, compliance can improve, as ownership and participation help strengthen implementation.

Disposable Foam Earplugs

Roll down earplugs, made from expandable slow-recovery foam, help provide the best combination of comfort and protection for most users. Once in the ear, foam earplugs expand to help provide a snug and secure insertion. 3M™ E-A-R™ Products offer a wide range of disposable earplugs, from the famous yellow 3M™ E-A-R™ Classic™ Earplug through to sophisticated shaped options such as the 3M™ E-A-RSoft™ Grippers Earplugs.



Pod Plugs

There is no roll needed; just use the soft flexible grip to push the earplug into position. Because you do not have to touch the foam during inserting, it is one of the most hygienic types of earplug available. Take a look at the disposable 3M™ E-A-R™ Push-In™ Earplug or for a reusable option try out the 3M™ E-A-R™ Express™ Earplug.



Reusable Pre-moulded Earplugs

Premolded earplugs are made from flexible materials that are preformed to fit the ear. They are generally available with a joining cord to prevent loss. These reusable earplugs are comfortable, hygienic and economical. No sizing is required for these patented, pre-moulded, triple flange earplugs. Available in a variety of styles and protection levels.



Semi-aurel

Banded hearing protectors are easy to use, convenient and extremely comfortable. They are quick to put on and off and to store around the neck when not required making them ideal for intermittent use. They are so easy to insert as well. Most models are available with spare pods, making them an economical option.



Earmuffs

3M™ PELTOR™ Earmuffs consist of rigid cups with soft plastic cushions that seal around the ears to block noise. They are a popular choice in hearing protection due to their ease of use and ability to effortlessly check that workers are wearing their hearing protection. They are available in headband, neckband, helmet-attachable and folding models to meet virtually every application need and wearer preference.



3M™ PELTOR™ Products Hearing Protection



PELTOR™



3M™ PELTOR™ Bullseye I Earmuff Foldable Earmuffs for Military

The 3M™ PELTOR™ Bullseye I Earmuff has been developed for demanding noisy environments and muffles even extremely low frequencies. The sealing rings are filled with a unique combination of liquid and foam. The result is an excellent seal with low contact pressure, which helps provide agreeable comfort even during long-term use. The sealing rings have ventilation channels and are covered with soft, patterned, hygienic foil.

H515FB-508-GN

Frequency (Hz)	125	250	500	1000	2000	4000	8000
Mean Attenuation (dB)	10.9	17.3	26.6	28.3	33.5	37.8	37.9
Standard Deviation (dB)	3.2	2.5	2.2	2.7	2.6	2.0	2.6
Assumed Protection (dB)	7.7	14.8	24.4	25.6	30.9	35.7	35.3

SNR=27dB H=32dB M=24dB L=15dB

Description **3M product code** **Reference Id**
Bullseye I XH001658265 H515FB-508-GN



3M™ PELTOR™ Bullseye III Earmuff Earmuffs for Military

The 3M™ PELTOR™ Bullseye III Earmuff is a high performance hearing protector and has been developed for use in high noisy environments. The protection is based on a technology with a double casing minimising resonance in the holder casing resulting in high-frequency attenuation. An acoustic connection between the inner volume and the volume between the casings in its turn provides low-frequency attenuation.

H540A-441-GN

Frequency (Hz)	125	250	500	1000	2000	4000	8000
Mean Attenuation (dB)	17.4	24.7	34.7	41.4	39.3	47.5	42.6
Standard Deviation (dB)	2.1	2.6	2.0	2.1	1.5	4.5	2.6
Assumed Protection (dB)	15.3	22.1	32.7	39.3	37.8	43.0	40.0

SNR=35dB H=40dB M=32dB L=23dB

Description **3M product code** **Reference Id**
Bullseye III XH001658562 H540A-441-GN



3M™ PELTOR™ Earmuffs - X Series Hearing Protection

Introducing the newest innovation in non-electronic earmuffs from 3M™ PELTOR™ Earmuffs. X-Series combine our extensive knowledge of hearing protection with our most advanced technologies to create the best non-electronic earmuff 3M PELTOR has ever made.

- Most durable 3M™ PELTOR™ Earmuff
- Broadest range of protection from a 3M™ PELTOR™ Earmuff line
- Modern & sleek design

	X1	X2	X3	X4	X5
Over-the-Head SNR*	27 dB	31 dB	33 dB	33 dB	37 dB
Helmet Mounted SNR*	26 dB	30 dB	32 dB	32 dB	36 dB

*Research suggests that many users will receive less noise reduction than indicated by the SNR due to factors including variation fitting skill and motivation of the user. It is recommended that the SNR be reduced by 50% to better estimate typical workplace protection.



3M™ E-A-R™ Products Hearing Protection



3M™ E-A-R™ Combat Arms™ Earplugs Hearing Protector, double ended



Specially developed for the military. Open Mode: this earplug's patented design allows wearers to hear low-level sounds critical to mission safety – conversation, footsteps, rifle bolts. When needed, the earplug reacts to help provide instant protection from high level impulse noises like weapons fire and explosions. Closed Mode: for hearing protection against constant noise (aircraft, armored vehicles, etc.) without hear-through.

- Patented dual-protection design
- Low-level sounds heard clearly
- High-impulse noise blocked instantly
- Premolded triple-flange design fits most ear canals
- Comfortable and reusable
- No batteries or moving parts

Description	3M product code	Reference Id
Combat arms dubble ended in a Black box	GT600003146	BX-01-012
Combat arms dubble ended in a Brown box	70071521226	370-1011

3M™ E-A-R™ Combat Arms™ Hearing Protector, double ended

Frequency (Hz)	63	125	250	500	1000	2000	4000	8000
Mean Attenuation (dB)	25.8	26.4	22.9	24.4	26.4	30.4	36.8	41.4
Standard Deviation (dB)	5.5	5.4	5.4	7.2	5.7	5.4	6.3	6.7
Assumed Protection (dB)	20.3	21.0	17.5	17.2	20.7	25.0	30.5	34.7

Steady State mode SNR=24dB H=26 M=21 L=19

Peak noise reduction in Combat mode

External Peak Sound Leevel (dB)	110	130	150	170	190
Peak Noice Reduction (dB)	3.4	12.3	17.0	24.7	32.1
Standard Devaition (dB)	1.5	0.8	0.7	0.2	1.6

3M™ E-A-R™ Combat Arms™ Earplugs Hearing Protector, single ended



The ISL non linear ear-plugs are designed specifically for use in a combat environment to provide situational awareness and protect against high level of peak impulse noise from small arms and artillery weapons fire. The subjective attenuation measurements against continuous noise are carried out in accordance with EN352-2:2002 whilst the peak impulse noise protection is assessed and reported by the Institute of St. Louis against an internal military test protocol.

Full details of the attenuation measurements are shown below.

The SNR and HML values are: **H = 20, M = 11, L = 6 SNR = 15**

At 110dB the ISL plug reduces the peak noise level by approximately 8dB, this rises to 25dB at a peak pressure of 190dB.

To ensure the peak sound level effective to the ear remains below the Peak Exposure Limit Value of 140dBC, it is recommended the product be restricted to a maximum external level of 155dBC peak.

Description	3M product code	Reference Id
Skin colour with shorter stem, bulk	70071573037	370-1400

3M™ E-A-R™ Combat Arms™ Passive Hearing Protector, single ended

Frequency (Hz)	63	125	250	500	1000	2000	4000	8000
Mean Attenuation (dB)	3.0	3.5	5.6	10.5	16.6	24.5	27.3	25.6
Standard Deviation (dB)	3.5	3.3	2.8	1.7	3.5	2.7	2.8	3.3
Assumed Protection (dB)	-0.5	0.2	2.8	8.8	12.1	21.8	24.5	22.3

SNR=15dB H=20dB M=11dB L=6dB

Peak noise reduction

External Peak Sound Leevel (dB)	110	130	150	170	190
Peak Noice Reduction (dB)	4.5	12.8	17.1	21.4	24.6
Standard Devaition (dB)	1.3	0.8	0.8	0.3	1.4



3M™ E-A-R™ Classic™ Earplugs

Hearing Protector



Description

Classic Amigo, Small
Classic, Medium
SuperFit 36, Large

3M product code

GT600000589
XA007701882
XA007707434

Reference Id

AM-01-000
PP-01-002
SF-01-003

2 pair Classic in black box
Ear plugg box, Blue

GT600003120
HC000609178

BX-01-010
BI003



Earplug Box
Storage box for Ear plugs.

3M™ E-A-R™ Classic™ Earplugs are made from a soft energy absorbing polymer foam which helps provide excellent hearing protection and all day comfort. Ideal for use where noise is a problem, either in work or leisure activities.

3M™ E-A-R™ Classic™ Small Earplugs are also available for users who are looking for all the benefits of the E-A-R™ Classic™ Earplugs but who want greater comfort in smaller ear canals.

3M™ E-A-R™ Classic™ Passive Hearing Protector

Frequency (Hz)	63	125	250	500	1000	2000	4000	8000
Mean Attenuation (dB)	22.3	23.3	24.6	26.9	27.4	34.1	41.6	40.4
Standard Deviation (dB)	5.4	5.3	3.6	5.4	4.8	3.1	3.5	6.4
Assumed Protection (dB)	16.9	18.1	20.9	21.5	22.6	30.9	38.1	34.0

SNR=28dB H=30dB M=24dB L=22dB

3M™ Combat Arms™ Earplugs - Generation 4.1

Hear-Through™ Protection



The 3M™ Combat Arms Re-usable Earplugs (CAE) Version 4.1 are designed for insertion into the ear canal to help reduce exposure to hazardous noise including steady state and peak noise from weapons fire, for example.

This product features a special acoustical filter that lets lower level sound through with relatively little noise reduction for greater situational awareness, and provides increasing amount of peak noise reduction as sound levels increases above 110 dB. This is called the Open Mode.

When used in the Closed Mode the product acts as a conventional earplug offering protection against steady state and peak impulse noise.

The Open Mode is activated when the rocker switch featuring 'CAE' is pressed and the Closed Mode is activated when the rocker switch featuring '3M' is pressed.

Subjective attenuation in accordance with EN352-2:2002 in the Closed Mode

Frequency (Hz)	63	125	250	500	1000	2000	4000	8000
Mean Attenuation (dB)	28.3	27.9	26.8	28.3	27.2	31.5	33.0	39.2
Standard Deviation (dB)	5.8	4.3	4.4	3.4	4.0	4.4	2.3	4.9
Assumed Protection (dB)	22.5	23.6	22.4	24.9	23.2	27.1	30.7	34.3

SNR=28dB H=28dB M=25dB L=24dB

Subjective attenuation in accordance with EN352-2:2002 in the Open Mode

Frequency (Hz)	63	125	250	500	1000	2000	4000	8000
Mean Attenuation (dB)	5.7	5.8	7.9	10.1	17.3	23.9	23.3	28.3
Standard Deviation (dB)	2.5	2.8	3.1	2.3	2.6	3.4	2.7	5.4
Assumed Protection (dB)	3.2	3.0	4.8	7.8	14.7	20.5	20.6	22.9

SNR=16dB H=20dB M=12dB L=7dB

Peak noise reduction values in the Open Mode as determined by the Institute of Saint-Louis (ISL) Laboratory, France.

External Peak Sound Level (dB)	110	130	150	170	190
Peak Noise Reduction (dB)	4.8	13.9	17.0	23.5	30.2
Standard Deviation (dB)	1.8	0.4	0.5	0.6	0.7

Key Features:

- Specially designed soft retainer helps ensure the earplug remains seated inside the ear canal.
- Rocker assembly featuring the patented mechanical filter for protection against high level of peak impulse noise
- Rocker switch is marked with '3M' and 'CAE' to easy switching between Closed Mode and Open Mode.
- Made from soft and durable material
- Available in three sizes for best individual fit
- Offers high attenuation against peak impulse noise- can be used up to 160dB peak
- Easy to wash and clean
- Supplied in a durable storage case featuring a convenient metal chain.
- All three sizes supplied with a soft polyester cord as standard

Description

Combat Arms 4.1 Small (500 PR/CS)
Combat Arms 4.1 Medium (500 PR/CS)
Combat Arms 4.1 Large (500 PR/CS)

3M product code

70071655628
70071655636
70071655664



Cross Section Of Ear

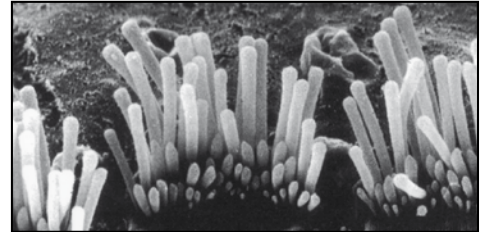
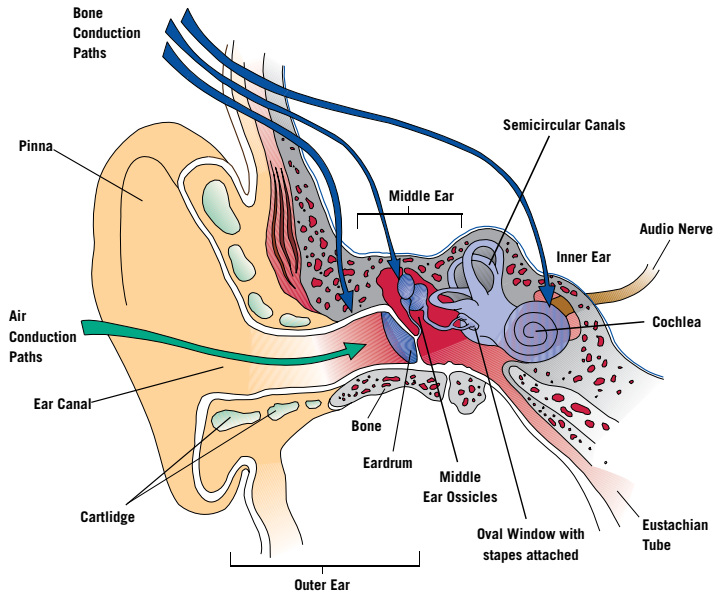

Normal, uninjured ear. An electron microscope shows the hair cells with their fine stereocilia, which are put into motion by sound waves.

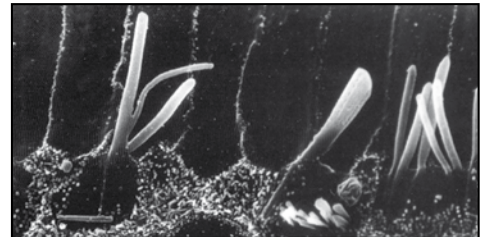

Noise damaged ear. The tiny hairs have been repeatedly exposed to loud noise and eventually broken. Permanent hearing loss has occurred.

The human ear is designed to pick up natural sounds. All of our exciting machines and inventions have created a whole range of unnatural sounds that the ear isn't designed to handle. When the stereocilia are repeatedly exposed to excessive doses of noise, they break. The surviving stereocilia can only handle a fraction of the usual information transfer, and permanent hearing damage is the result.

You only have two

One of five senses. Two ears for a whole life. And a damaged ear cannot be repaired. Noise in the workplace is the most common cause of hearing impairment. We can only tolerate a limited daily dosage of noise. How harmful the noise is depends on the exposure time in combination with the sound level. Five minutes of carelessness during an eight-hour working day could result in impaired hearing for the rest of your life. Full-time wear is therefore the only way to guarantee protection. Most people are aware of this, but are still careless because they perceive hearing protection as heavy or uncomfortable, or because they can't hear what their colleagues are saying. But how do you convince people to wear hearing protection all the time? Well, just make it easy to wear!

Measuring Noise Levels

3M has a comprehensive range of noise measurement solutions used extensively in the military to accurately measure noise exposure levels. Area noise can be measured with a sound level meter whilst a dosimeter is used to more precisely measure the exposure of a specific individual. All Hearing Conservation programmes start with a reliable understanding of the noise risk so the right steps can be taken to reduce the risk and ensure staff are appropriately protected.



The importance of wearing hearing protection 100% of time exposed to noise



100% usage
Gives the highest hearing protection.



99% usage
Just five minutes of carelessness per day significantly increase the risk of hearing damage.



90% usage
The hearing protection is drastically reduced.

Safety

To be effective, a hearing protector should be used 100% of the time in noisy environments. Even taking it off for a short time dramatically reduces its effectiveness and greatly increases the risk of hearing damage. The 3M™ PELTOR™ Headsets with level-dependent microphones for ambient listening and Bluetooth® function encourage longer use because the wearer feels less isolated and can communicate with others more easily.

Easy To Damage - Easy To Protect

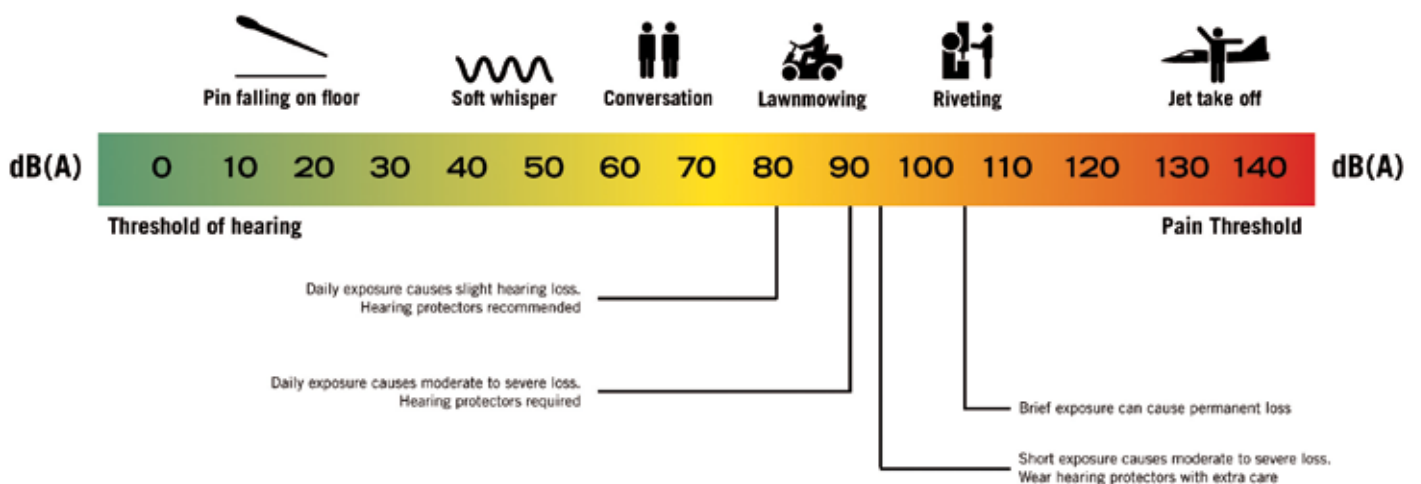



Passive Headsets



PELTOR™

Headbands



Headband (A)

Stainless spring steel. Soft padded cushion – comfortable even during long-term use.



Neckband (B)

Combines with many types of other protective equipment, such as welding shield.



Folding headband (F)

Takes little space in toolbox or pocket. Sealing rings are protected against soiling and damage.

Cup size



Low Attenuation

Fits under the typical combat helmet.

SNR 25-26dB(A) (Depending on model)



Medium Attenuation

SNR 30-31dB(A) (Depending on model)



High Attenuation

SNR 31-35dB(A) (Depending on model)



PELTOR™

Military Headset Combinations

Helicopter Rescue (MT21H61FA)

Headset specially made for the rescue diver. This headset makes it possible for the rescue diver to communicate with the crew in the helicopter during his mission when he is in the water. The headset is built to stand the environment in the water both under and above the surface. This headset makes it possible to make the mission to go faster and give the rescue diver a safer mission.



Twin-Cup High Attenuation (MT72H540F-38)

NSN number: 5965-25-150-9672

- Extra high-attenuating twin shells with optimised acoustic design and excellent space for the ears for the best possible sound quality and comfort
- Effective noise cancelling microphone for clear and reliable communication
- Quick Positioning integrated microphone boom for easy handling
- Soft, wide, foam and fluid-filled ear cushions and individually sprung head band wires of stainless sprung steel help provide an even and consistent distribution of pressure around the ears for the best possible comfort
- Overhead and helmet-attached versions to meet most users' requirements



High Attenuation (MT7H79F-38)

NSN number: 5965-25-150-9674

- High-attenuating shells with optimised acoustic design and excellent space for the ears for the best possible sound quality and comfort
- Effective noise cancelling microphone for clear and reliable communication
- Quick Positioning integrated microphone boom for easy handling
- Soft, wide, foam and fluid-filled ear cushions and individually sprung head band wires of stainless sprung steel help provide an even and consistent distribution of pressure around the ears for the best possible comfort
- Standard J11 connection (Nexus TP-120)
- Beam-mounted earphones that provide the least possible resonance and distortion for excellent sound reproduction even in very high-noise environments
- Numerous configurations. Overhead, neckband and helmet-attached versions to meet most users' requirements



Medium Attenuation (MT7H61FA-38)

NSN number: 5965-25-150-9673

- Low-profile shells for easy, comfortable use together with other PPE devices
- Low weight
- Effective noise cancelling microphone for clear and reliable communication
- Quick Positioning microphone for easy handling
- Soft, wide, foam and fluid-filled ear cushions and individually sprung head band wires of stainless sprung steel help provide an even and consistent distribution of pressure around the ears for the best possible comfort
- Beam-mounted earphones that provide the least possible resonance and distortion for excellent sound reproduction even in high-noise environments
- Available in standard version with J11 (Nexus TP-120) connector. Also available in a direct-connected version on request.
- Choose between Head- or neck band





PELTOR™

Ground crew headset (special made on request)

Headset made to be in very high noise around jetfighters. In such a high noise hearing loss can be caused in just seconds. The headset has secure straps so it can't slip away from the position on the head.

For more information please contact the 3M Technical Service in Varnamo.



Waterproof Headset for Helmet (special made on request)

PPN: 07-0128 (FL55-T9149)

Headset made to be build into rescue helmets. Direct connection to radio.
(Helmet not included)



Example of assembly



Joining Forces for Your Safety

More safety from one source

Since 2008, renowned PELTOR™ and E-A-R™ Products significantly broaden 3M's range of hearing, eye, face and head protection products. You will benefit from the combined forces of companies who have been setting standards worldwide in the occupational health field.

Protect your employees better than before with professional occupational health solutions that meet all your requirements.

A safe bet for even better performance

This new portfolio of 3M presents a huge advantage for you as customer and user because by joining forces we will be able to develop even better and more comfortable personal protective equipment solutions. This can lead to enhanced protection, more comfort and increased productivity. Quality, innovation and know-how will continue to be the distinguishing features of every one of our products – for increased safety and ease of use.

To answer any questions you may have related to occupational health, the contacts you already know will continue to be available to you with the same good service you have become accustomed to.



Diverse range of personal protective equipment

The combined portfolio of 3M, PELTOR™ and E-A-R™ Products include high-quality, innovative solutions to protect people at work. Here are some examples:

Respiratory protection



Active & passive hearing protection



Eye protection



Head protection



Welding protection



Protective coveralls



Noise Measurement & Heat stress monitors



Find out more and visit our Website www.3M.EU/Safety

3M does not accept liability of any kind, be it direct or consequential (including, but not limited to, loss of profits, business and/or goodwill) arising from reliance upon any information herein provided by 3M. The user is responsible for determining the suitability of the products for their intended use. Nothing in this statement will be deemed to exclude or restrict 3M's liability for death or personal injury arising from its negligence.

ATTENTION! This literature will not serve as basis or data for contracts or quotations



3M Personal Safety Division

3M Svenska AB, Box 2341

SE-331 02 Värnamo

Sweden

Phone: +46 (0) 370 65 65 65

Fax: +46 (0) 370 65 65 99

Internet: www.3M.EU/Safety

Please recycle. Printed in Sweden.

© 3M 2015. All rights reserved.

The Bluetooth® word mark and logos are registered trademarks owned by Bluetooth SIG, Inc. and any use of such marks by 3M Company is under license.

3M and all other trademarks used herein are trademarks of 3M Company, used under license in Canada. PELTOR is a trademark of 3M Svenska AB, used under license in Canada.